

SPECTRUM Winco®

GAS COUNTERTOP EQUIPMENT, NATURAL / LP GRIDDLES

Operating Instruction Manual



NGGD-24M



NGGD-36M



NGGD-48M



SANITATION



Model	Burner(s)	BTU/ Burner	Total BTU/HR	Pressure IN. W.C	Orifice Size	Overall Dimensions			Griddle Surface		Weight
						Length	Depth*	Height	Length	Depth	
NGGD-24M	2	30,000	60,000	4" / 10"	Nat #39 LP #50	24" (609.6mm)	29-1/8" (739.7mm)	15-1/2" (393.7mm)	24" (609.6mm)	20-3/4" (527.1mm)	144 lbs (71 kg)
NGGD-36M	3		90,000			36" (914.4mm)			36" (914.4mm)		202 lbs (100 kg)
NGGD-48M	4		120,000			48" (1219.2mm)			48" (1219.2mm)		255 lbs (126 kg)

*Overall dimensions include the gas regulator located on the back of the unit

BEFORE OPERATING ANY EQUIPMENT, READ AND FAMILIARIZE YOURSELF WITH THESE USE AND SAFETY INSTRUCTIONS

Congratulations on your purchase of this SPECTRUM™ Griddle. When used as intended, and with proper care and maintenance, you are sure to experience years of reliable operation from this equipment. To ensure best results, it is important that you read and follow the instructions in this manual carefully. **It is important to keep these instructions in a safe place for future reference.**

GAS GRIDDLE

Important For Future Reference

Please complete this information and retain this manual for the life of the equipment. For Warranty Service and/or parts, this information is required.

Model Number

Serial Number

Date Purchased



WARNING: For your safety, do not store or use gasoline or other flammable vapors or liquids in the vicinity of this or any other appliances. Keep the area free and clear of combustibles. (See ANSI Z83. 14B, 1991).

AVERTISSEMENT: Pour votre sécurité, ne pas stocker ni utiliser d'essence ou d'autres vapeurs ou liquides inflammables à proximité de cet appareil ou d'autres appareils. Garder la zone libre de combustible. (Voir la norme ANSI Z83. 14B, 1991).



WARNING: Improper installation, adjustment, alteration, service or maintenance can cause property damage, injury, or death. Read the installation operating and maintenance instructions thoroughly before installing, or servicing this equipment.

AVERTISSEMENT: Une installation, un réglage, une modification, un entretien ou peut causer des dommages matériels, des blessures ou la mort. Lisez les instructions d'exploitation et de maintenance d'installation avant d'installer, ou sauvegarder cet équipement.



WARNING: Instructions must be posted in a prominent location. All safety precautions must be taken in the event the user smells gas. Safety information can be obtained from your local gas supplier.

AVERTISSEMENT: Les instructions doit être affichées dans un endroit bien en vue. Toutes les mesures de sécurité doit être prises en cas d'odeur de gaz. Les consignes de sécurité peut être obtenue auprès de votre fournisseur de gaz local.



CAUTION: These models are designed, built, and sold for commercial use only. If these models are positioned so the general public can use the equipment, make sure that cautions, warnings, and operating instructions are clearly posted near each unit so that anyone using the equipment will use it correctly and not injure themselves or harm the equipment.

ATTENTION: Ces modèles sont conçus, fabriqués et vendus pour un usage commercial seulement. Si ces modèles sont positionnés de sorte que le grand public peut utiliser l'équipement, assurez-vous que mises en garde, les avertissements et les instructions sont clairement affichés unité de sorte que toute personne utilisant l'équipement va l'utiliser correctement et de ne pas nuire à injurethemselves ou l'équipement.



WARNING: A factory authorized agent should handle all maintenance and repair. Before doing any maintenance or repair, contact your authorized service representative.

AVERTISSEMENT: Un agent autorisé de l'usine doit traiter tout l'entretien et la réparation. Avant de faire tout entretien ou réparation, contactez votre représentant de service autorisé.



GAS PRESSURE

The appliance and its individual shutoff valve (to be supplied by user) must be disconnected from the gas supply piping system during any pressure testing of that system at test pressures in excess of ½ psi (3.45 kPa).

The appliance must be isolated from the gas supply piping system by closing its individual manual shut-off valve during any pressure testing of the gas supply piping system at test pressures equal to or less than ½ psi (3.45 kPa).

PRESSION DE GAZ

L'appareil et la vanne d'arrêt individuel (à fournir par l'utilisateur) doit être débranchés de la tuyauterie d'alimentation en gaz pendant tout test de pression de ce système à des pressions d'essai supérieures à ½ psi (3.45 kPa).

L'appareil doit être isolé du système de conduites d'alimentation en gaz en fermant son robinet manuel d'arrêt individuel durant tout test de pression du système de tuyauterie d'alimentation en gaz à des pressions inférieures à ½ psi (3.45 kPa).

GAS GRIDDLE

Table of Contents

Specifications.....	1
Warnings	2
Introduction	3
Safety Precautions	4
Packaging	4
Installation	5
Conversion	6-7
Lighting Pilot	7
Safety	8
Operation	8
Cleaning, Care & Maintenance	8
Troubleshooting	9
Service & Repair	9
Exploded Views	10
Spare Parts List	11
Limited Warranty	12

Introduction

Congratulations on the purchase of your SPECTRUM™ machine. Please take time to carefully read through this manual to ensure the machine is operated and maintained properly, to ensure the best possible performance from the product for many years.

SPECTRUM will not accept liability for the following if:

- The instructions in this manual have not been followed correctly.
- Non-authorized personnel have tampered with the machine.
- Non-original spare parts are used.
- The machine has not been handled and cleaned correctly.
- There is any use damage to the unit.

LOCATION OF DATA PLATE

The data plate is located on the rear or side panel.

IMMEDIATELY INSPECT FOR SHIPPING DAMAGE

All containers should be examined for damage before and during unloading. The freight carrier has assumed responsibility for its safe transit and delivery.

If equipment is received damaged, either apparent or concealed, a claim must be made with the delivering carrier.













- A. Apparent damage or loss must be noted on the freight bill at the time of delivery. It must then be signed by the carrier representative (Driver). If this is not done, the carrier may refuse the claim. The carrier can supply the necessary forms.
- B. If concealed damage or loss is not apparent until after equipment is uncrated, a request for inspection must be made to the carrier within 15 days. The carrier should arrange an inspection. Be certain to keep all contents and packaging material.

Installation should be performed by a qualified installer who thoroughly read, understands and follows these instructions.

If you have questions concerning the installation, operation, maintenance or service of this product, please contact WINCO®.

Please keep this manual in a safe place for future use!

Safety Precautions

 <p>DANGER: This symbol warns of imminent hazard which will result in serious injury or death.</p>	<p>Risque: Ce symbole avertit du danger imminent qui peut entraîner des blessures graves ou la mort.</p> 
 <p>WARNING: This symbol refers to a potential hazard or unsafe practice, which could result in serious injury or death.</p>	<p>AVERTISSEMENT: Ce symbole indique un danger potentiel ou une pratique dangereuse, qui peut entraîner des blessures graves ou la mort.</p> 
 <p>CAUTION: This symbol refers to a potential hazard or unsafe practice, which could result in minor or moderate injury or product or property damage.</p>	<p>ATTENTION: Ce symbole indique un danger potentiel ou une pratique dangereuse, qui peut entraîner des blessures mineures ou modérées ou des dommages matériels.</p> 
 <p>NOTICE: This symbol refers to information that needs special attention or must be fully understood even though not dangerous.</p>	<p>AVIS: Ce symbole renvoie à des informations qui nécessite une attention particulière ou doit être pleinement compris, même si pas dangereux.</p> 
 <p>NOTICE: This product is intended for commercial use only. Not for household use.</p>	<p>AVIS: Ce produit est destiné à un usage commercial. Pas pour usage domestique.</p> 
 <p>NOTICE: Local codes regarding installation vary greatly from one area to another. The National Fire Protection Association, Inc., states in its NFPA 96 latest edition that local codes are "Authority Having Jurisdiction" when it comes to requirement for installation of equipment. Therefore, installation should comply with all local codes.</p>	<p>AVIS: Les codes locaux concernant l'installation varient grandement d'une région à l'autre. La National Fire Protection Association, Inc., déclare dans sa dernière édition que NFPA 96 codes locaux sont "Autorité Compétente" lors de l'exigence pour l'installation d'équipements. Par conséquent, l'installation doit être conforme à tous les codes locaux.</p> 

Package Contents

All units come with Installation & Operation Instructions and the following:

- (1) Griddle Set
- (1) Grease Drawer
- (4) Adjustable Legs
- (1) Natural to LP Gas Conversion Kit

SPECTRUM™ prides itself on quality and service, ensuring that at the time of packing, all products are supplied fully functional and free of damage. Should you find any damage as a result of freight, please contact your SPECTRUM dealer immediately.

NOTE

Please remember that this manual and the warning labels do not replace the need to be alert, to properly train and supervise operators, and to use common sense when using this equipment.

Unpacking the Equipment

DISPOSE OF ALL PACKAGING MATERIALS IN AN ENVIRONMENTALLY RESPONSIBLE MANNER.

1. Remove all packing materials and tape, as well as any protective plastic and cardboard, from the unit.
2. Clean any glue residue left over from the plastic or tape.
3. ENSURE THAT THE COUNTERTOP WILL SUPPORT THE WEIGHT OF GRIDDLE.
4. Place the unit in the desired position and height.

SAVE THE ORIGINAL BOX AND PACKAGING FOR USE IN PACKAGING AND SHIPPING THE EQUIPMENT IF SERVICES ARE NEEDED.

Installation

These instructions should be followed at all times. Failure to follow these instructions could result in injury to yourself and others.

INSTALLATION CODES AND STANDARDS

The Griddle must be installed in accordance with:

In the United States of America:

1. State and local codes.
2. National Fuel Gas Code, ANSI -Z223.1/N FPA #54 (latest edition). This shall include but not be limited to: NFPA #54 Section 10.3.5.2 for Venting. Copies may be obtained from The American Gas Association Accredited Standards Committee Z223, @ 400 N. Capital St. NW, Washington, DC 20001 or the Secretary Standards Council, NFPA, 1 Batterymarch Park Quincy, MA 02169-7471

NOTE: In the Commonwealth of Massachusetts

All gas appliances vented through a ventilation hood or exhaust system equipped with a damper or with a power means of exhaust shall comply with 248 CMR.

3. NFPA Standard # 96 Vapor Removal from Cooking Equipment, latest edition, available from the National Fire Protection Association, Batterymarch Park, Quincy, MA 022 69.

In Canada:

4. Local codes.
5. CAN/CSA-B 149.1 Natural Gas Installation (latest edition)
6. CAN/CSA-B 149.2 Propane Installation Code (latest edition), available from the Canadian Gas Association, 178 Rexdale Blvd., Etobicoke, Ontario, Canada M9W 1R3

TO REDUCE RISK OF INJURY OR DAMAGE TO THE UNIT:

1. Read this manual thoroughly before installation and operation. DO NOT proceed with installation and operation if you have any questions or do not understand anything in this manual. Contact your representative or the manufacturer first.
2. Remove the SPECTRUM Gas Griddle from the packaging. Be certain that all protective plastics and residues are thoroughly cleaned from its surface.
3. Place the Griddle on a firm level surface. Local standards and regulations should be consulted in order to abide by standards set in relation to positioning, spacing, and ventilation.
4. Ensure gas supply and gas type, as shown on unit nameplate, agree.

WARNING ⚠️ AVERTISSEMENT	
 <p>Burn Hazard. When in operation, the appliance will be hot. <i>Please take extreme caution.</i></p>	<p>Risque de brûlure. Ne touchez pas les surfaces chaudes ou chauffées liquid tout appareil chauffe ou en fonctionnement.</p>
	<p>USE CAUTION WHEN TOUCHING THE UNIT.</p>

Leg Installation:

The Griddle must not be operated without the legs attached.

1. Install adjustable legs by screwing leg post into recess nut at each corner of unit frame. Level unit by turning lower foot clockwise or counter clockwise as required.

Gas Pressure Regulator Installation:

2. Gas regulator pressure is preset at 4" Water Column (W.C.) for Natural gas, and 10" W.C. for L.P. Propane gas. Minor adjustments may be required, based on site-specific gas pressure.
3. Install the regulator as close to the Griddle on the gas supply line as possible. Make sure that the arrow on the underside of the regulator is oriented in the direction of gas flow to the Griddle (Fig.1), and the regulator is positioned with the vent plug and adjustment screw in upright position (Fig .2).



Fig.1



Fig.2

4. The minimum supply pressure (upstream of the regulator) should be 7"-9" W.C. for Natural gas and 10"-12" W.C. for L.P. Propane gas. At no time should the Griddle be connected to a supply pressure greater than ½ psig (3.45 k Pa) or 14" W.C.

Leveling:

Turn the feet at the bottom of the legs (after legs are installed on unit) up or down to level the Griddle in the final installed location.

Ventilation Hood:

For safe operation and proper ventilation, the Griddle should be installed under a suitable ventilation hood. Keep the space between the Griddle and vent hood free from any obstructions.

WARNING ⚠️ AVERTISSEMENT		
	<p>Fire Hazard. Correct installation precautions, procedures and regulations must be followed. Operation and safety training is necessary for all users of this equipment.</p>	<p>Risque d'incendie La surchauffe des vapeurs d'huile ou de l'huile peut s'enflammer et provoquer un incendie. Surveillez la température, la qualité et le niveau d'huile. Utilisez et entretenez le système d'élimination des vapeurs d'huile.</p>
	<p>The equipment must be installed by qualified personnel only. Correct installation precautions, procedures and regulations must be followed in order to reduce the risk of fire. Hood and fire suppression systems must be maintained per manufacturer's guidelines. Only qualified and trained personnel are to use this equipment.</p>	<p>Faire chauffer l'huile avec précaution. Si l'huile fume, réduire le feu. Ne pas laisser l'appareil sans surveillance. Si le feu se produit, éteindre l'appareil, couvrir jusqu'à refroidissement. Ne pas mettre l'eau dans l'huile chaude ou enflammée. Ne faites pas fonctionner avec de l'huile sous la barre d'huile. L'huile sale a un point d'éclair plus bas. Remplacer l'huile sur une base régulière. Maintenir le niveau d'huile correct. Utiliser un système d'évacuation de la vapeur d'huile (capot) pour réduire l'accumulation de graisse et d'huile sur les surfaces de paroi ou de plafond.</p>

Gas Connection:

1. The data plate on rear or side of the Griddle indicates the type of gas the unit is equipped to burn. **DO NOT** connect to any other gas type.

NOTE: Gas supply connections and any pipe joint compound must be resistant to the action of propane gases.

2. Purge the supply line to clean out any dust, dirt, or foreign matter before connecting the line to the unit.
3. Codes require that a gas shut-off valve be installed in the gas line ahead of the Griddle. The gas supply line must be at least the equivalent of $\frac{3}{4}$ " iron pipe.
4. A pressure regulator is supplied and must be installed outside of the broiler when making the gas supply connection. Standard orifices are set for 4" W.C. for Natural Gas / 10" W.C. for L.P. Propane. Use the 1/8" pipe tap on the burner manifold for checking pressure. Make sure the gas piping is clean and free of obstructions, dirt, and piping compound.
5. An adequate gas supply is necessary. Undersized or low-pressure lines will restrict the volume of gas required for satisfactory performance. A minimum supply pressure of 7"-9" W.C. for Natural gas and 10"-12" W.C. for L.P. Propane gas is recommended. With all units operating simultaneously, the manifold pressure on all units should not show any appreciable drop.
6. When testing the gas supply piping system:
 - If test pressures exceed $\frac{1}{2}$ psig (3.45 k Pa), the Hot Plate and its individual shutoff valve must be disconnected from the gas supply piping system.
 - When test pressures are $\frac{1}{2}$ psig (3.45 k Pa) or less, the Hot Plate must be isolated from the gas supply piping system by closing its individual, manual shut-off valve during any pressure testing of the system.

⚠ WARNING

DO NOT use an open flame to check for leaks. Check all gas piping for leaks with a soap and water solution before operating unit.

NE PAS utiliser une flamme nue pour vérifier les fuites. Vérifiez tous les tuyaux de gaz pour les fuites avec de l'eau savonneuse avant de l'unité d'exploitation.

TO AVOID SERIOUS PERSONAL INJURY:

- ALWAYS install equipment in a work area with adequate light and space.
- ONLY operate on a solid, level, nonskid surface.
- NEVER bypass, alter or modify this equipment in any way from its original condition. Doing so can create hazards and will void warranty.

NEVER operate the unit without all warnings attached to it.

THESE UNITS ARE SUITABLE FOR INSTALLATION ON NON-COMBUSTIBLE SURFACE(S) ONLY.

Combustible clearances:

6" sides (152 mm) 6" rear (152 mm) 4" floor (102 mm)

Noncombustible clearances:

0" sides (0 mm) 6" rear (152 mm) 4" floor (102 mm)

THIS EQUIPMENT GETS EXTREMELY HOT!

DO NOT POSITION AND OPERATE NEAR COMBUSTIBLE MATERIALS/ FLAMMABLE OBJECTS.

Do not obstruct the flow of combustion and ventilation air, under the unit by the legs or behind the unit by the flue.

Ne pas obstruer le flux de combustion et de ventilation, sous l'unité par les jambes ou derrière l'appareil par la cheminée.

Adequate clearance for air openings into the combustion chamber is required. Do not place objects between the bottom of the unit and the counter top.

Un dégagement adéquat pour des ouvertures d'air dans la chambre de combustion est nécessaire. Ne pas placer d'objets entre le bas de l'appareil et le comptoir.

There must be adequate clearance for removal of the front panel. All major parts except the burners are removable through the front if the gas line is disconnected.

Il doit y avoir un espace suffisant pour le retrait de la face avant. Toutes les parties principales à l'exception des brûleurs sont amovibles à travers l'avant si la conduite de gaz est coupée.

Conversion

These instructions are for the conversion from Natural Gas to Propane (L.P.) of the unit and kit provided. The conversion should be done before connecting the unit to the gas supply.

⚠ WARNING

An authorized licensed technician must perform the complete gas conversion of this unit. **DO NOT ATTEMPT TO DO YOURSELF.** Failure to properly convert this unit, can result in serious injury, property damage or death and will void warranty.

1. Remove the knobs and front panel (Fig.3).



Fig.3

Conversion

2. Unscrew bolts and pilot valve, then remove the manifold (Fig.4).



Fig.4

3. Replace the orifice fittings into the valve. **NOTE:** Unit number is on the side of orifice fittings (Fig.5).



Fig.5

4. Replace the front panel and knobs.
5. Before installing the included convertible regulator, unscrew the octagon cap. You can read (NAT) on the plastic insert attached to the head of the cap; flip it over and snap back in place (Fig.6).

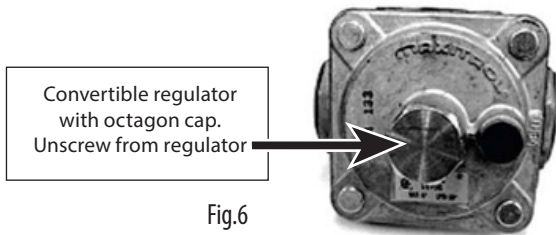

Fig.6

Pictured is the plastic insert. Pull off insert from octagon cap and reverse the plastic insert position so that the L.P. position is attached to the octagon cap head (Fig.7a, 7b).

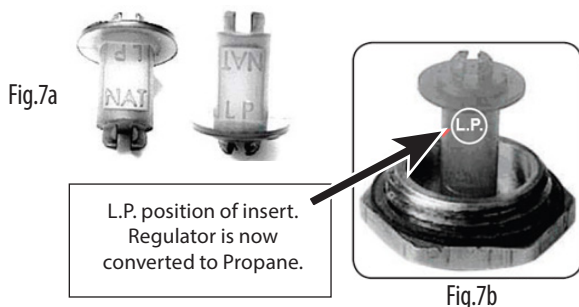

Fig.7b

6. Continue with installation.

Note

PLEASE CHECK LEAKAGE BEFORE RE-INSTALLING CONTROL PANEL.

Lighting Instructions

LIGHTING PILOT

The pilot light on the appliance has been set at the factory. A screwdriver may be required for the first lighting to adjust the flame for your elevation.

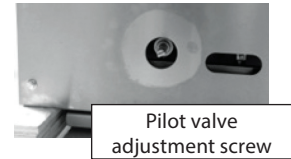
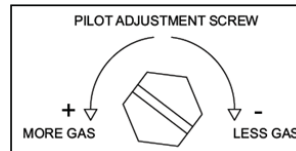

1. Turn off the manual valve and wait 5 minutes to clear the gas.
2. Turn all knobs to the "OFF" position.
3. Hold an ignition source (e.g. a lit match) at the pilot. When the flame is established, remove the ignition source. If necessary, adjust pilot flame height by turning pilot valve screw.
4. Turn the burner knobs to "ON". If the burner does not ignite, promptly open the pilot valve more. If the pilot flame appears larger than necessary, turn it down and reset burner ignition. The pilot flame should be as small as possible but large enough to guarantee reliable ignition of the burners when the knobs are turned to "ON".

LIGHTING MAIN BURNER

To light burner, turn knob to "ON". Then back off to the desired flame level. The range of adjustment is virtually infinite between "ON" and "OFF".

MAIN BURNER AIR SUPPLY

5. For efficient burner operation, a proper balance of gas volume and primary air supply must be maintained, which will result in complete combustion. Insufficient air supply results in a yellow streaming flame. Primary air supply is controlled by an air shutter on the front of the burner.
6. Loosen the screws on the front of the burner and adjust the air shutter to just eliminate the yellow tips of the burner flame. Lock the air shutter in place by tightening the screws.

CAUTION • ATTENTION

Clean the regulator at least once a month. Make sure the vent opening is open and not blocked in any way. Failure to do so will cause variations in pressure. Your unit will not function as well and it could shorten the life of the product.

Nettoyez le régulateur au moins une fois par mois. Assurez-vous que l'ouverture de l'évent est ouvert et non bloqué en aucune façon. Ne pas le faire entraîne des variations de pression. Votre appareil ne fonctionnera pas aussi bien et il pourrait raccourcir la durée de vie du produit.

CAUTION • ATTENTION

NEVER ATTEMPT TO MOVE A GRILL SECTION WHILE COOKING.

An unexpected flare could cause severe injury. Turn off the unit, let it cool and use potholders and/or gloves to reposition or remove.

The space between the legs at the bottom admits combustion air.

DO NOT BLOCK THIS SPACE.

Ne tentez jamais de déplacer une section de la grille pendant la cuisson. Une fusée inattendu pourrait causer des blessures graves. Éteignez l'appareil, le laisser refroidir et employer des gants isolants et/ou des gants pour repositionner ou supprimer. L'espace entre les jambes en bas admet l'air de combustion.

NE PAS BLOQUER CET ESPACE.

All burners are lit from constantly burning pilots. Turning the valve to the desired flame height is all that is required to put the unit in service.

Do not permit fans to blow directly at the unit. Wherever possible, avoid open windows next to the unit's sides or back. Avoid wall type fans which create air cross-currents within a room.

Tous les brûleurs sont allumés de pilotes brûlant constamment. Tourner la vanne à la hauteur de flamme désirée est tout ce qui est nécessaire pour mettre l'appareil en service.

Ne pas permettre aux fans de souffler directement à l'unité. Autant que possible, éviter les fenêtres ouvertes à côté des côtés ou à l'arrière des unités. Évitez les fans de type mur qui créent air contre-courants au sein d'une chambre.

It is also necessary that sufficient air be allowed to enter the room to compensate for the amount of air removed by any ventilating system. Otherwise, a subnormal atmospheric pressure will occur, affecting operation and causing undesirable working conditions.

Il est également nécessaire que l'air suffisant doit être autorisé à entrer dans la salle pour compenser la quantité de l'air extrait par un système de ventilation. Sinon, une pression atmosphérique inférieure à la normale aura lieu, affecter le fonctionnement et causer des conditions de travail indésirables.

A properly designed and installed hood will act as the heart of the ventilating system for the room or area in which the unit is installed, and will leave the unit independent of changing draft conditions.

Un capot correctement conçu et installé agira comme le cœur du système de ventilation pour la salle ou une zone dans laquelle l'appareil est installé, et laisser l'unité indépendante de l'évolution des conditions de tirage.

All valves must be checked and lubricated periodically. This must be done by an authorized service representative in your area.

Toutes les vannes doit être vérifiées et lubrifiées périodiquement. Cela doit être fait par un technicien de maintenance agréé dans votre région.

Safety

A WINCO® Approved Service Technician should carry out repairs if necessary. Do not remove any components or service panels on this product.

Allow the unit to cool down before dismantling for cleaning; the unit will be too hot to handle immediately after use!

Do not use hose or pressure wash to clean.

If the machine is damaged, it must be repaired by a WINCO Approved Qualified Service Technician in order to avoid a hazard.

Operation

Before operating the Griddle, check that it is sitting level. Adjust the feet at bottom to straighten and level the unit.

NOTE

Upon first use, the unit can produce a metal-burning smell. This is normal and the smell will decrease with use.

The Griddle and parts get very hot. Use caution when operating, cleaning or servicing the unit.

CONTROLS

Each burner is individually controlled by heavy-duty infinite control valves, with an input of 30,000 BTU/h.

Cleaning, Care & Maintenance

CAUTION • ATTENTION

Use only non-abrasive cleaners. Abrasive cleaners could scratch the finish of your unit, marring its appearance and making it susceptible to dirt accumulation. Do not use steel wool, other abrasive cleaners or cleaners/sanitizers containing chlorine, iodine, ammonia or bromine chemicals as these will deteriorate the stainless steel and glass material and shorten the life of the unit.

Utilisez seulement des nettoyeurs non-abrasifs. Les nettoyeurs abrasifs pourraient rayer la finition de votre unité, rayer son apparence et rendre sensible à l'accumulation de saleté. Ne pas utiliser de laine d'acier, d'autres nettoyeurs abrasifs ou les nettoyeurs/désinfectants contenant du chlore, de l'iode, l'ammoniac ou bromine produits chimiques que ceux-ci vont se détériorer l'acier inoxydable et de verre et de raccourcir la durée de vie de l'appareil.

INITIAL CLEANING

Prior to operation, wash the griddle plate and unit exterior with a mild detergent or soap solution. DO NOT USE ABRASIVE CLEANERS. If the stainless steel surfaces become discolored, rub clean only in the direction of the finished grain.

SEASONING THE GRIDDLE

Heat to low temperature (300 - 350°F/150-180 °C) and pour a small amount of cooking oil onto the griddle plate (about one ounce (30cc) per square foot of surface). Spread the oil over the entire griddle surface with a cloth to create a thin film. Wipe off any excess oil with a cloth. Repeat this procedure 2 to 3 times until the griddle has a slick, mirror-like surface.

DAILY CLEANING

1. Always turn unit off and allow it to cool completely before cleaning. Clean thoroughly before first use.
2. After each use, thoroughly clean back, sides, top and front of unit.
3. Clean trivets daily.
4. Empty and clean grease drawer daily.

WEEKLY

1. Clean unit thoroughly. Clean stainless steel or chromed surfaces with a damp cloth and polish with a soft, dry cloth. A detergent may be used for cleaning. To remove discolorations, use a non-abrasive cleaner.
2. Burner air shutter openings must be kept clean. Main burner ports must be kept clean. To clean stainless steel burners brush with a wire brush or clean gas ports with a sharp-pointed metal instrument to ensure open ports.

Troubleshooting

If the SPECTRUM™ Gas Griddle does not operate properly, please check the following before placing a service call:

ISSUE	MIGHT BE CAUSED BY	RECOMMENDED SOLUTION
Pilot will not light.	No gas supply or gas isolation valve is OFF.	Ensure the gas isolation valve is turned on, and that the gas tanks are not empty.
	Pilot burner is clogged/blocked.	Check the pilot burner if clogged, and clean, or replace if necessary.
	Pilot valve is closed.	Open the pilot valve.
Pilot flame is very small and can be easily blown out by a small draft.	Pilot valve opening is at a minimum.	Adjust pilot valve to the desired flame, enough to withstand the surrounding draft and light the burner.
	Pilot head is partially blocked.	Check the pilot head for any blockage. Clean or remove the blockage. Replace the pilot head if necessary. Replace pilot valve.
	Faulty or broken pilot valve.	Ensure that the gas tanks are not empty, and the gas isolation valve is turned ON.
Main Burner will not light.	No gas supply or gas isolation valve is OFF.	Adjust the gas supply pressure to required standard.
	Insufficient gas supply pressure.	NG – 4" W.C. and LPG - 10" W.C.
	Clogged or blocked burner injector.	Clean the burner injector or replace it if necessary.
	Faulty or broken gas valve.	Replace the gas valve.
Main Burner and Pilot Burner suddenly shut off.	Not enough gas supply pressure.	Ensure that the gas tanks are not empty and there is enough gas supply. Otherwise, contact your gas dealer.
Flame does not come out from some of the holes of the main burner.	Holes are clogged with carbon or food debris.	Clean the burner or replace it if necessary.
Burner and Pilot flame color is yellow.	Wrong gas type used.	Check the gas type used, change to the correct gas type.
	Wrong orifice installed.	Check the orifice installed. Replace it with correct orifice for the gas type used.
Yellow tipping of flames.	Lack of primary air due incorrect air shutter adjustment.	Open the air shutters to get rid of yellow flame.
	Lint and dust may have blocked primary air openings or have collected inside the burner tube or on the underside of the burner ports which reduced primary air injection.	a. Clean and readjust the burner's air shutter. b. Replace the burners if necessary.
	The burner orifice/injector might have spun out of line.	Check and realign the injector to the burner.
	Blocked or clogged injector orifice.	a. Check and clean the injector orifice. b. Replace it if necessary.

Service and Repair

THIS EQUIPMENT MUST ONLY BE SERVICED BY AN AUTHORIZED AGENT.

NOTE

Parts protected by the manufacturer or its agent are not to be adjusted by the installer unless the installer is an authorized service agent.

If you have any questions or problems DO NOT send unit to WINCO® without first contacting our customer service department.

See "Limited Warranty" section on page 12 for details.

Exploded Views

MODEL SHOWN: NGGD-SERIES

24" unit shown

Internal

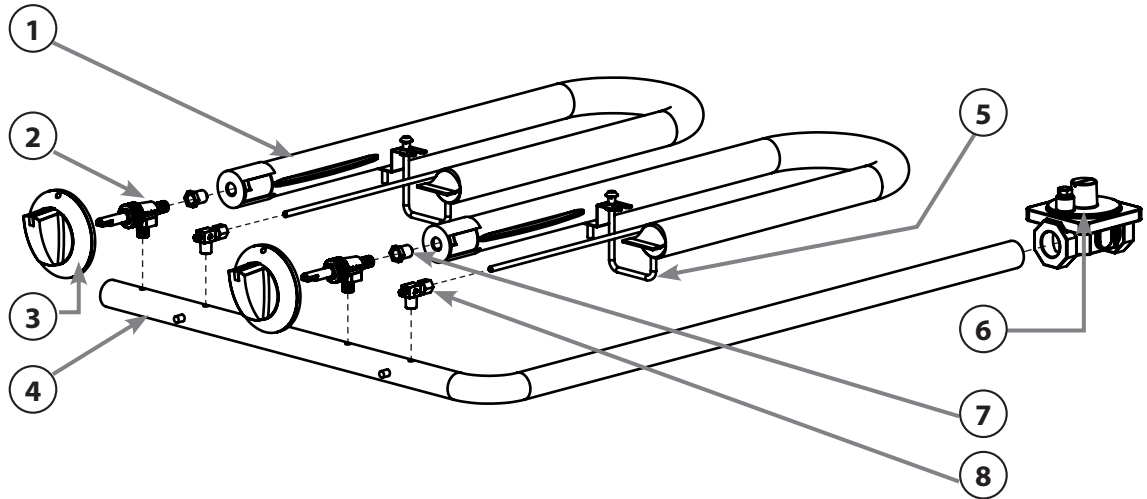

External

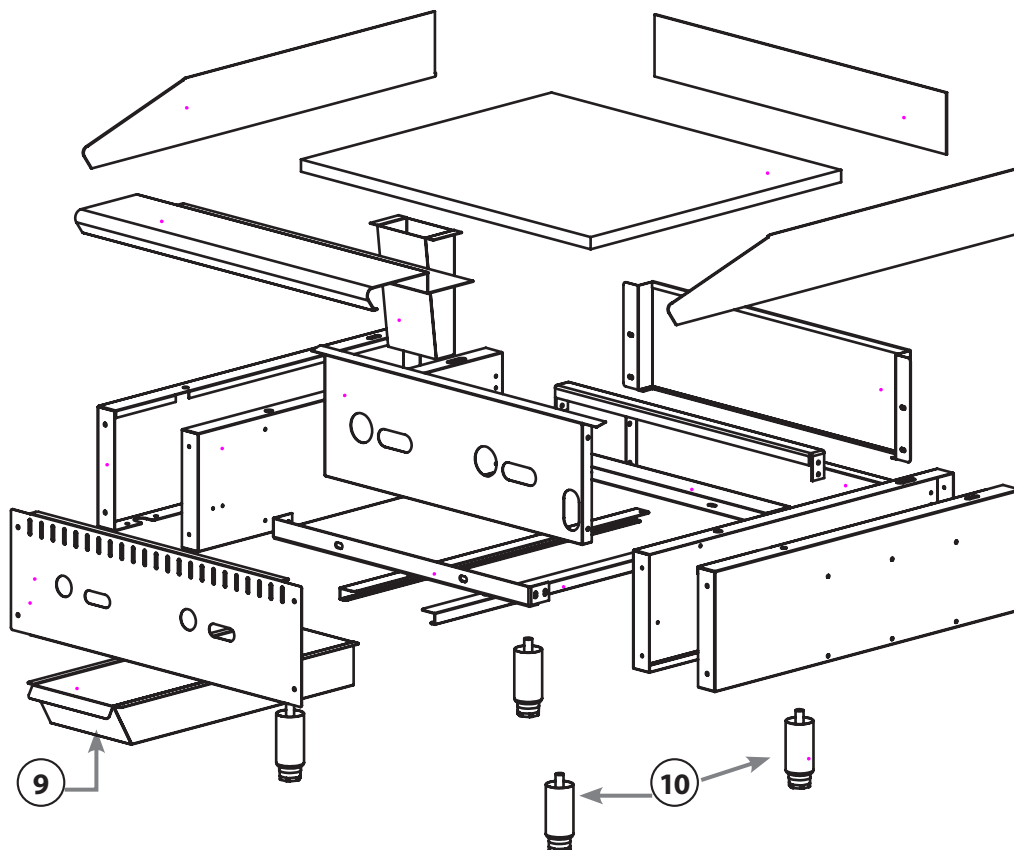

Spare Parts List

MODELS: NGGD-24 / NGGD-36 / NGGD-48

GAS GRIDDLE		NGGD-24	NGGD-36	NGGD-48
NO.	DESCRIPTION	PART #	PART #	PART #
1	U-Shaped Pipe Burner	NG-UP	NG-UP	NG-UP
2	Manual Gas Valve A18	NG-MGV	NG-MGV	NG-MGV
3	Knob	NG-KNOB	NG-KNOB	NG-KNOB
4	Main Intake Pipe	NG-MIP	NG-MIP	NG-MIP
5	Pilot Tube	MG-PT	MG-PT	MG-PT
6	Gas Pressure Regulator	NG-RGL	NG-RGL	NG-RGL
7	#39 Natural Orifice	NGGD-P3	NGGD-P3	NGGD-P3
	#50 LP Orifice	NGGD-P4	NGGD-P4	NGGD-P4
8	Pilot Valve AP7	NG-PVAP7	NG-PVAP7	NG-PVAP7
9	Grease Drawer	NGGD-P2	NGGD-P2	NGGD-P2
10	4" to 6" Adjustable Leg	NG-FOOT	NG-FOOT	NG-FOOT

Please contact factory for special order parts not listed.

Limited Warranty

WINCO® warrants to the original purchaser of new equipment that said equipment, when installed in accordance with our instructions within North America and subjected to normal use, is free from defects in material or workmanship for a period of 1 year. The labor warranty is one year from original installation or 18 months from actual factory shipment date, whichever date occurs first.

THIS WARRANTY IS IN LIEU OF ALL OTHER WARRANTIES, WHETHER EXPRESSED OR IMPLIED. WINCO EXPRESSLY DISCLAIMS ANY IMPLIED WARRANTY OF MERCHANTABILITY OR EXPRESSED OR IMPLIED WARRANTY OF FITNESS FOR A PARTICULAR PURPOSE.

WINCO'S OBLIGATION AND LIABILITY UNDER THIS WARRANTY IS EXPRESSLY LIMITED TO REPAIRING AND REPLACING EQUIPMENT WHICH PROVES TO BE DEFECTIVE IN MATERIAL OR WORKMANSHIP WITHIN THE APPLICABLE WARRANTY PERIOD.

IN NO EVENT SHALL WINCO BE LIABLE FOR INCIDENTAL OR CONSEQUENTIAL DAMAGES TO BUYER OR ANY THIRD PARTY, INCLUDING, WITHOUT LIMITATION, LOSS OF PROPERTY, PERSONAL INJURY, LOSS OF BUSINESS OR PROFITS OR OTHER ECONOMIC LOSSES, OR STATUTORY OR EXEMPLARY DAMAGES, WHETHER IN NEGLIGENCE, WARRANTY, STRICT LIABILITY, OR OTHERWISE.

This warranty is given only to the first purchaser from a retail dealer. No warranty is given to subsequent transferees.

Warranty does not cover product failures caused by: failure to maintain, neglect, abuse, damage due to excess water, fire, normal wear, improper set up and use. Periodic maintenance is not covered.

This warranty is not in force until such time as a properly completed and digitally signed Installation/Warranty Registration has been received by WINCO within 30 days from the date of installation.

WARRANTY SERVICE

To initiate warranty service contact: equipservice@wincous.com or call: 973-295-3899

DO NOT send unit to WINCO without first contacting our customer service department.

REGISTER ONLINE AT:

<http://support.wincous.com>

Proof of purchase is required to extend warranty more than 1 year from date of shipment from the factory.

THE FOREGOING WARRANTY PROVISIONS ARE A COMPLETE AND EXCLUSIVE STATEMENT BETWEEN THE BUYER AND SELLER. WINCO NEITHER ASSUMES NOR AUTHORIZES ANY PERSONS TO ASSUME FOR IT ANY OTHER OBLIGATION OR LIABILITY IN CONNECTION WITH SAID EQUIPMENT.

Examples of items not covered under warranty, but not limited to just these items:

1. Acts of God, fire, water damage, burglary, accident, theft.
2. Freight damage.
3. Improper installation or alteration of equipment.
4. Use of generic or after market parts.
5. Repairs made by anyone other than a WINCO designated service provider.
6. Lubrication.
7. Expendable wear parts, adjustable feet, blown fuses, lamps, etc.
8. Cleaning of equipment.
9. Misuse or abuse.

Please keep this manual in a safe place for future use!

Models: NGGD-24 / NGGD-36 / NGGD-48

www.wincous.com